

NOTE: FOR MORE DETAILS SEE YOUR V.P.CUSTOMER SERVICE REP.

REVISIONS			
REV.	DESCRIPTION	DATE	APPROVED
A	INITIAL RELEASE	09-15-97	
B	CO 046 Drafting Update	09-27-07	Rick C.
C	Changed Post Specification	12-10-07	Rick C.

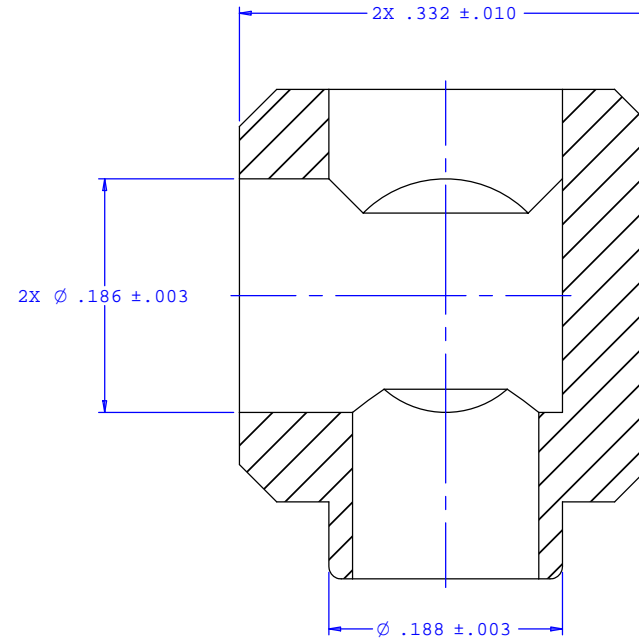

SECTION A-A

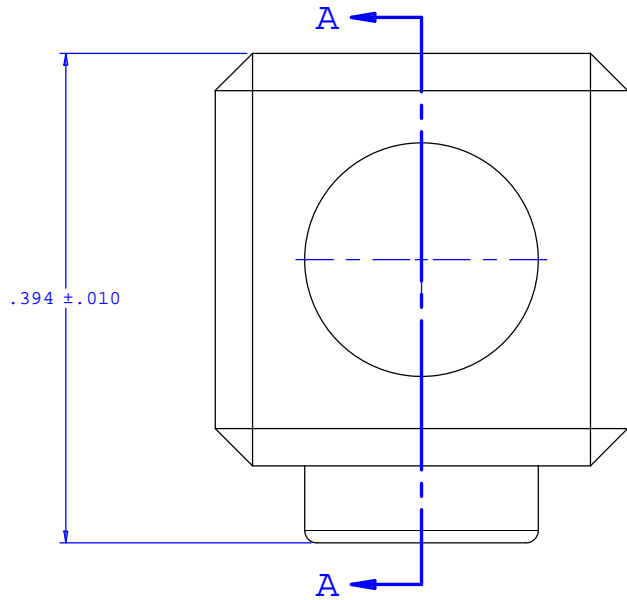
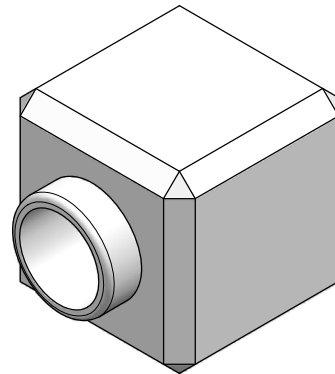

UNLESS OTHERWISE SPECIFIED DIMENSIONS ARE IN INCHES TOLERANCES ARE:		VALUE PLASTICS, INC.	
FRACTIONS ±	DECIMALS .XX ±.01 .XXX ±.005 .XXXX ±.001	ANGULAR ±1°	PART NUMBER: BDJ12
DO NOT SCALE DRAWING		DESCRIPTION: Bondable Junction Block	
DRAWN BY: Frank Lombardi	DATE: 05-02-06	SIZE: B SCALE: NTS	DRAWING NUMBER: 1008734
Engineer/Manager: Rick Cairns		© 2006 VALUE PLASTICS, INC.	REV. C SHEET: 1 OF 1

FOR REFERENCE ONLY